

AT89C5131A Starter Kit

Hardware User Guide



Section 1

Introduction	1-1
1.1 Features	1-1

Section 2

Hardware Description	2-3
2.1 Block Diagram	2-3
2.2 Power Supply	2-4
2.3 C51 Standard Settings	2-5
2.4 Feature Description	2-6
2.5 External Connectors	2-8

Section 3

Device Programming	3-9
3.1 In-System Programming	3-9
3.2 Using a Programmer	3-9

Section 4

Appendix	4-11
4.1 Electrical Schematics	4-12
4.2 Component Placement	4-16
4.3 Mechanical Outlines	4-17
4.4 Bill of Materials	4-17



Section 1

Introduction

This document describes the AT89C5131A Starter Kit Evaluation Board dedicated to the AT89C5131A USB microcontroller. This board is designed to allow an easy evaluation of the product using demonstration software (refer to Software Guide).

1.1 Features

The AT89C5131A evaluation board provides the following features:

- Possibility to choose between two packages for the AT89C5131A
 - PLCC 52-pin package
 - VQFP 64-pin package
- On-board power supply circuitry
 - from an external power connector
 - from an external battery
 - from the USB line via the USB on-board connector
- On-board reset, INT0, LEDs, EA, ISP and programming interface
- Power, ALE, RS232 Rx and Tx LEDs
- External system clock connector
- PCA clock connector
- USB, TWI, SPI and RS232 hardware connectors
- Two Connectors available for extended board

Figure 1-1. AT89C5131A Evaluation Board

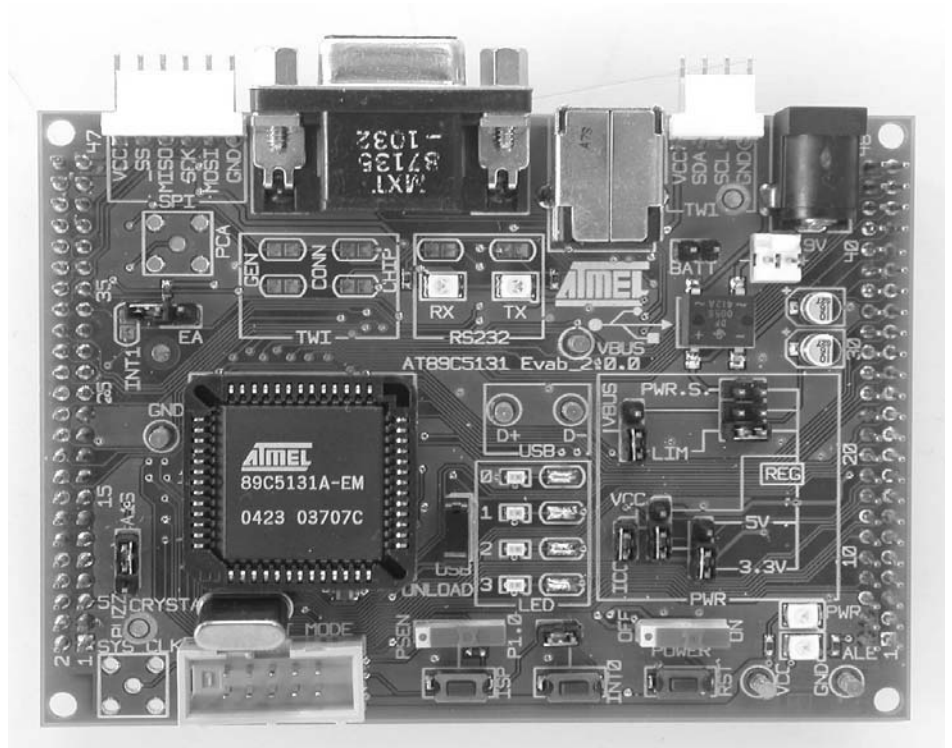

Section 2

Hardware Description

2.1 Block Diagram

Figure 2-1. AT89C5131A Evaluation Board Components

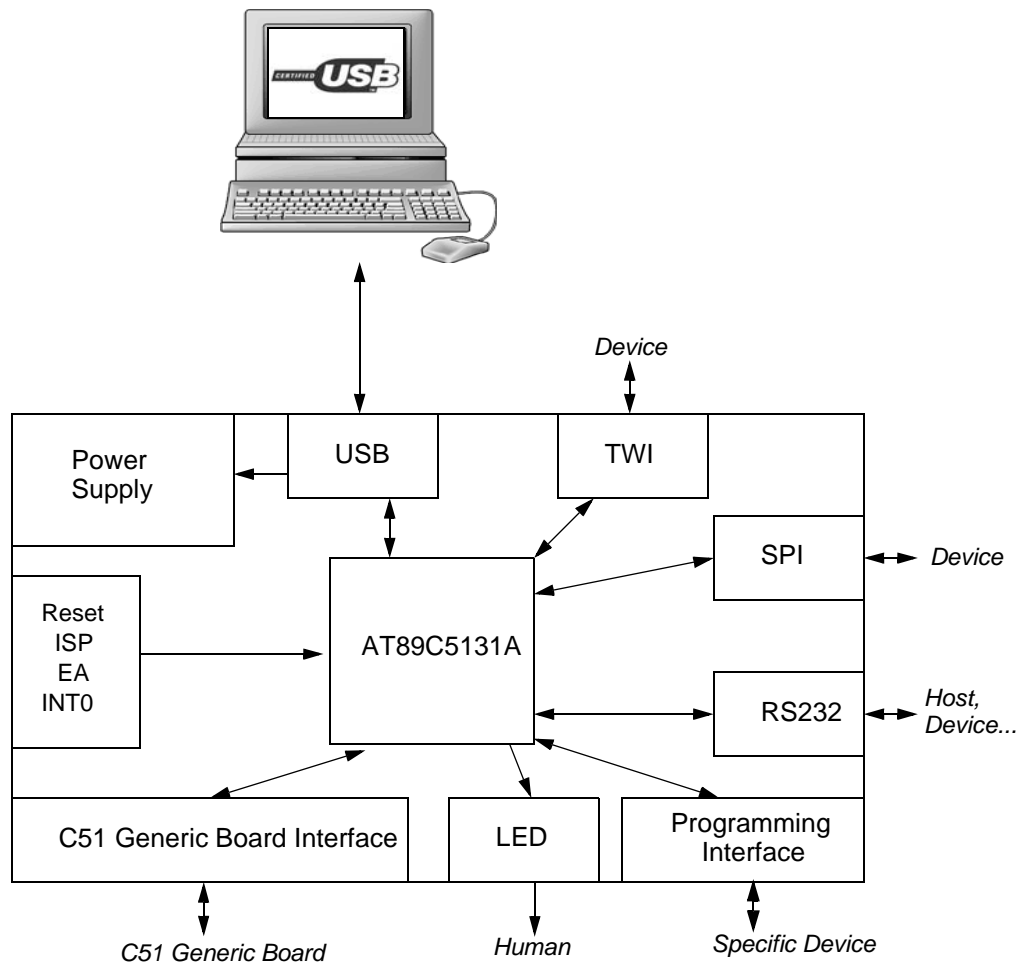

2.2 Power Supply

The on-board power supply circuitry allows various power supply configurations.

The power source can be:

- V_{BUS} from USB (5V)
- V_{BUS} from USB (5V) through the current limiter
- External power supply (from 6 to 12V) or 9V battery

The voltage output can be the direct power source, regulated at 5V or 3.3V.

The power supply selection is performed using the JP2, JP3, JP4 and JP5 jumpers.

The power supply can be turned on/off using the “power” switch (SW6). Once the power is established, the power LED (D9) is lit.

Figure 2-2. Different Power Configurations

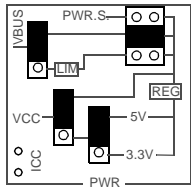
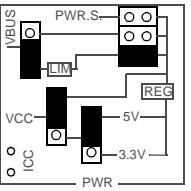
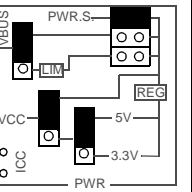
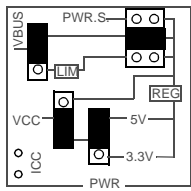
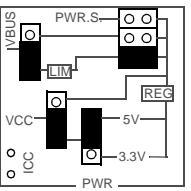
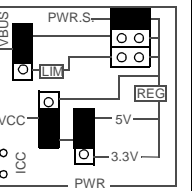
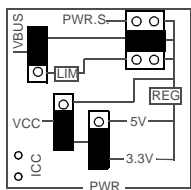
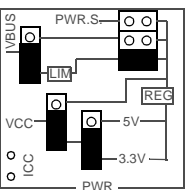
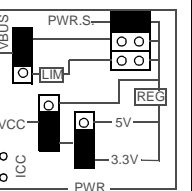
Power Source Regulation	VBUS	VBUS and Current Limiter	External
Direct Input			
5V Regulate			
3.3V Regulate			

2.3 C51 Standard Settings

- 2.3.1 Reset** The external Reset push-button (SW3) is provided to easily generate a warm reset. This button is used for ISP process. The Reset applied is active low.
- 2.3.2 Clock** A crystal can be easily installed on the Y1 socket. The clock can also be provided using the J8 connector instead of the crystal.
- Note:** Remove the clock generators before the using the programmer.
- 2.3.3 EA** Place a jumper on the EA connector (J10) to force the \overline{EA} pin to ground and execute external code. Otherwise internal code will be executed.

Figure 2-3. \overline{EA} Circuitry

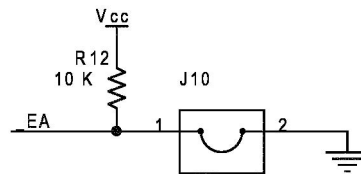

- 2.3.4 INT0** In order to use the on-board INT0 circuitry, connect the J7 Jumper to the AT89C5131A. When you press the INT0 button (SW5), the P3.2 pin will go low which induces an interrupt event.
- Note:** Remove the J7 jumper before using the programmer. Otherwise the programmer will not function.

Figure 2-4. $\overline{INT0}$ Circuitry

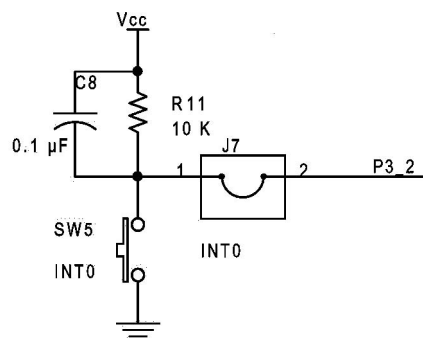

2.4 Feature Description

2.4.1 RS232 The AT89C5131A evaluation board includes all the required hardware to manage the RS232 communication.

Figure 2-5. RS232 On-board Circuitry

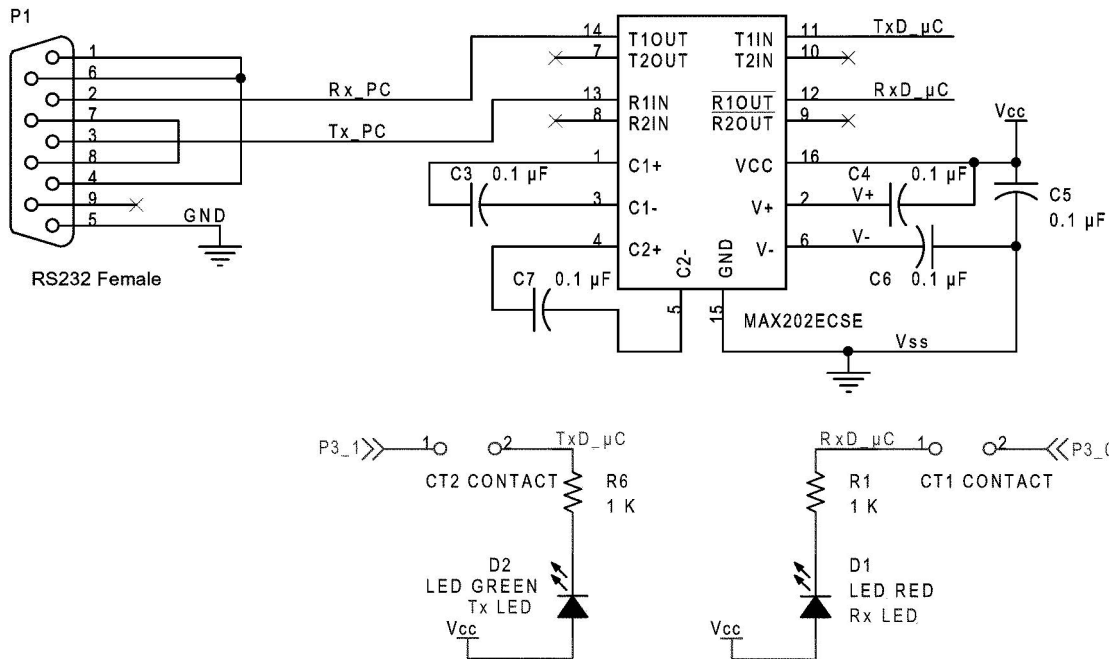

2.4.2 USB Peripheral The AT89C5131A evaluation board provides all the required hardware to develop a USB firmware for the AT89C5131A, this includes:

- a USB connector
- 2 test points on D+ and D-
- 1 test point on V_{BUS}
- a USB UNLOAD button which allows to disconnect the pull-up on D+ and then to simulate an Attach/Detach of the USB cable

The USB peripheral can also be used to perform an In-System Programming.

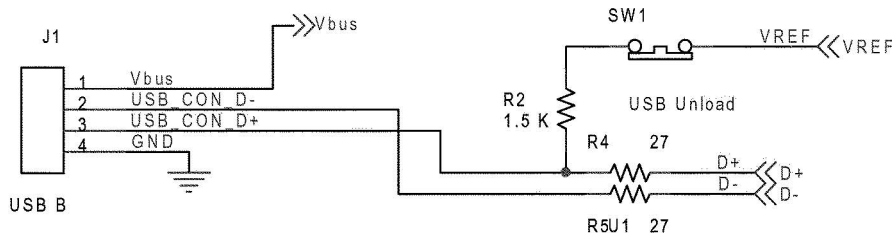

2.4.3 TWI Peripheral

The CT3 and CT5 contacts have to be soldered in order to use the SDA and SCL alternate P4.1 and P4.0 port configuration on the SPI connector (J4).

In order to use these signals on the J5 extension connector (SDA and SCL), the CT4 and CT6 contacts have to also be soldered.

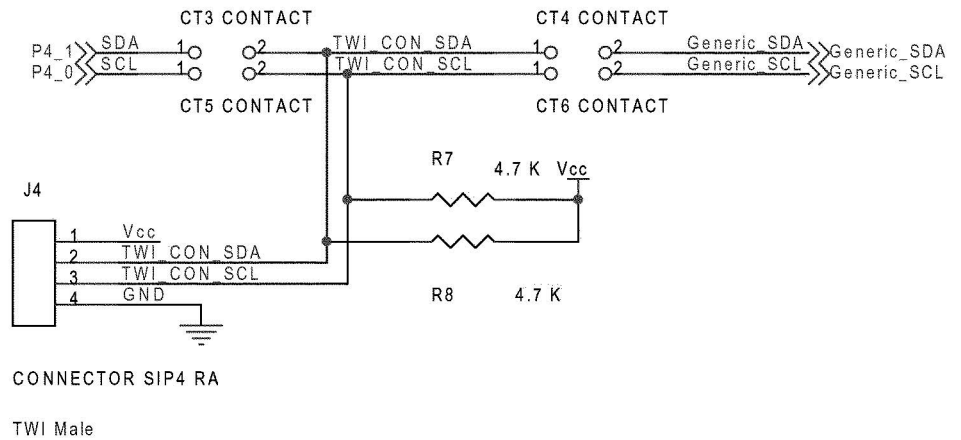

2.4.4 SPI Peripheral

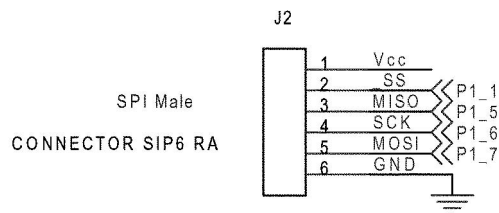

2.4.5 LED Controller

The AT89C5131A controller includes an LED controller on:

- P3.3 (LED 0)
- P3.5 (LED 1)
- P3.6 (LED 2)
- P3.7 (LED 3)

The on board LEDs can be controlled with the AT89C5131A if the corresponding contacts CT9, CT10, CT11 and CT12 are bypassed.

Figure 2-6. On-board LEDs for LED Controller

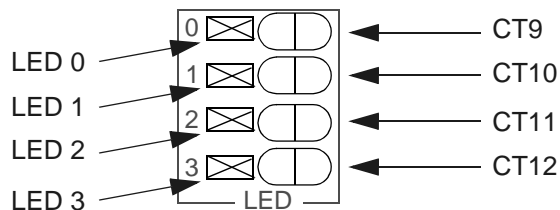

2.5 External Connectors

These two external connectors to build a customer extended board easily.

Figure 2-7. Top View of J5 and J6 Connectors

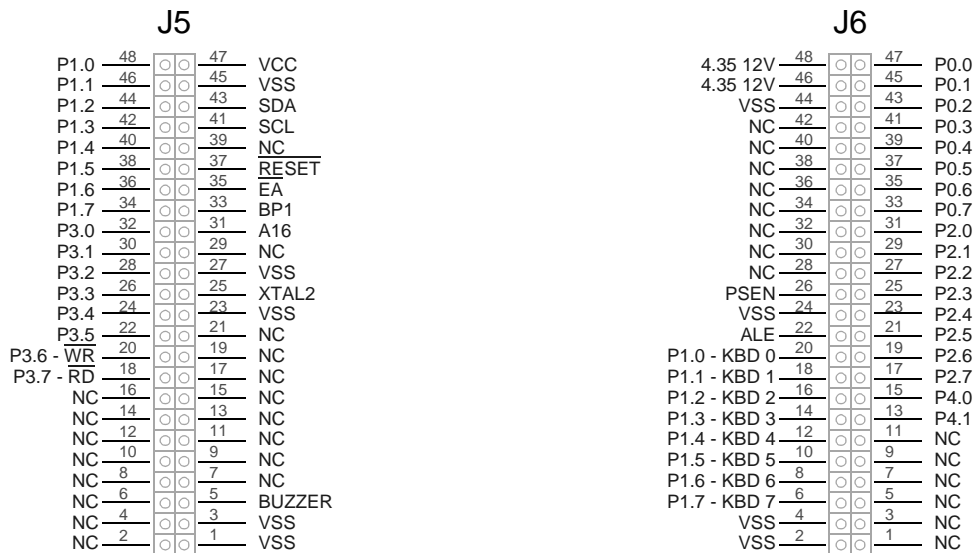



Section 3

Device Programming

- 3.1 In-System Programming**
- The user memory of the AT89C5131A part can be programmed using the ISP mode of the device. In order to enter in ISP mode, first select the high pin count mode (PSEN) or the low pin count mode (P1.0) using the ISP switch (SW2).
- To enter in ISP mode, press both the RESET (SW3) and ISP (SW4) buttons simultaneously. First release the RESET button and then the ISP button. The device enters in ISP mode.
- ISP can then be performed using the USB bus (or with the peripheral corresponding with the bootloader version). The user may need to re-enumerate the USB bus using the USB UNLOAD button (SW1) if the USB cable is already connected.
-
- 3.2 Using a Programmer**
- The AT89C5131A microcontroller can also be programmed using a programmer with the J3 connector. Connect all required signals between the programmer and the J3 connector and remove the J7 jumper to disconnect the EA circuitry. No clock should be enabled on the board, except the clock coming from the J3 connector.

Figure 3-1. J3 Connector Schematic

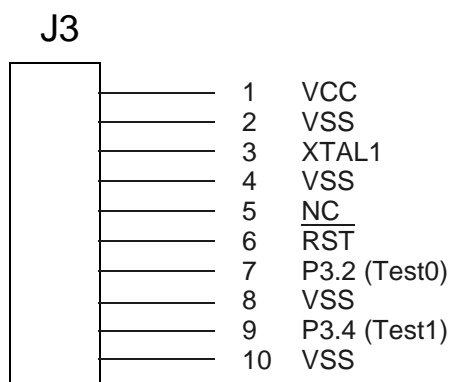



Section 4

Appendix

4.1 Electrical Schematics

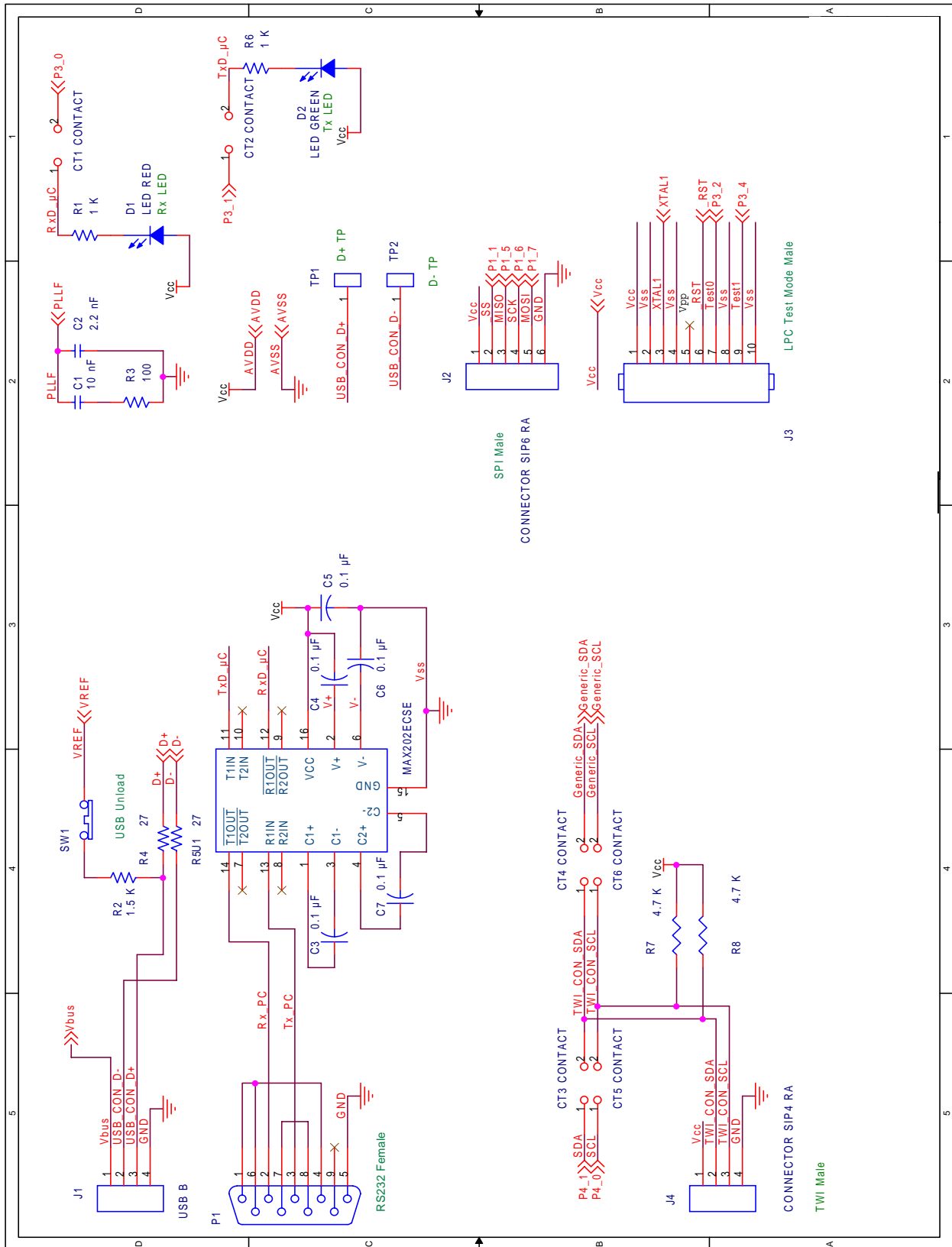

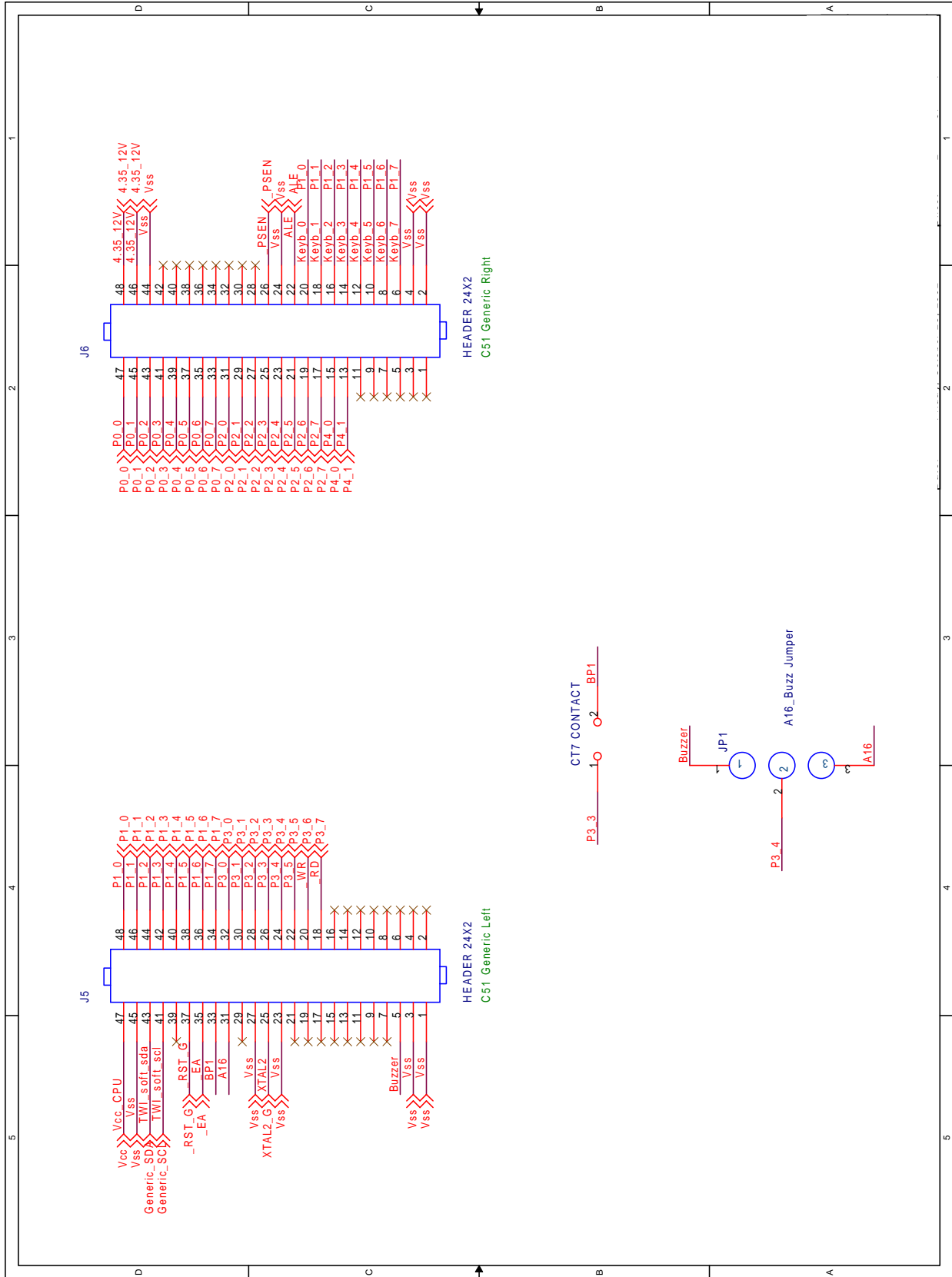

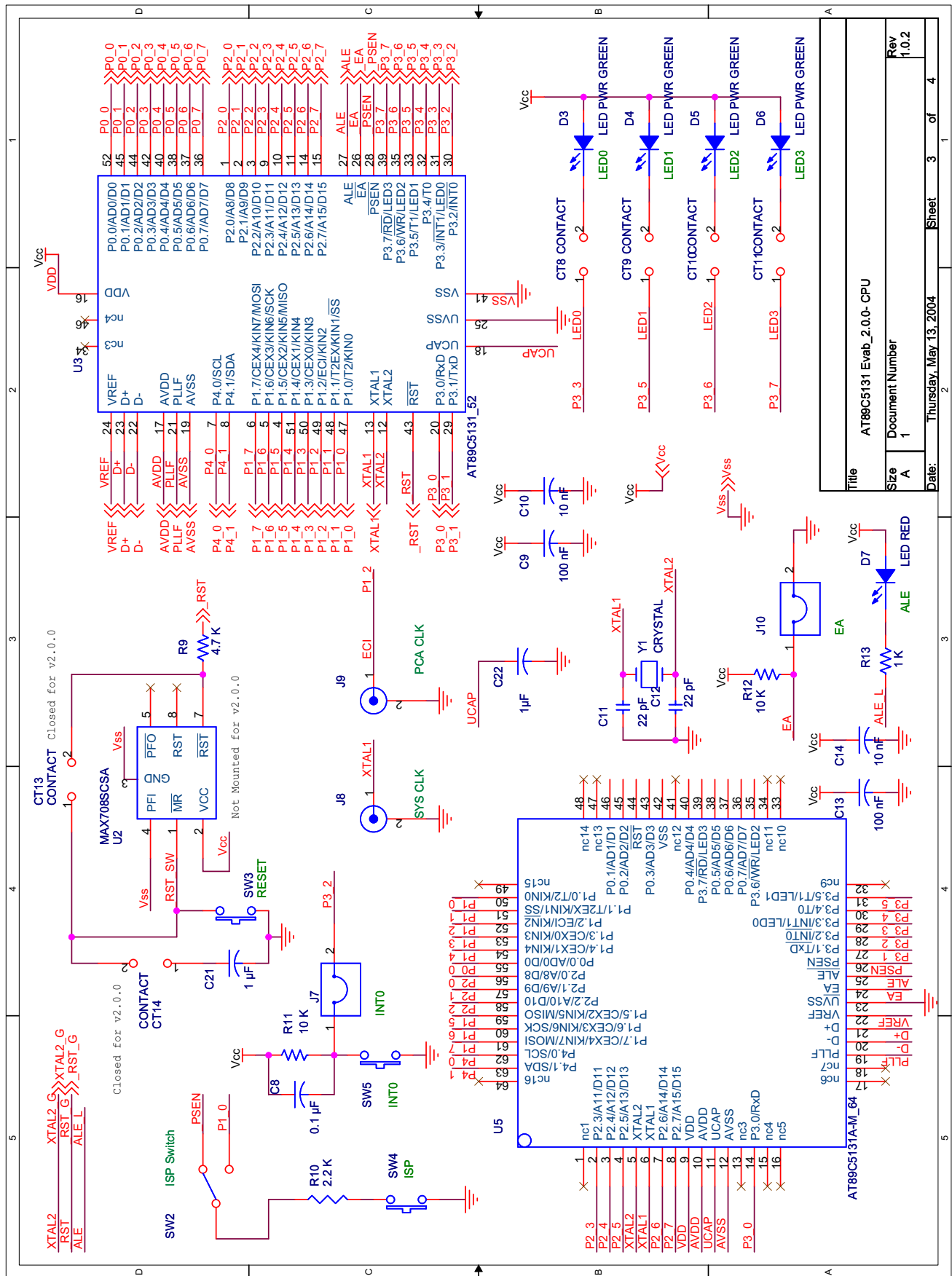

Title		AT89C5131 Eval_2.0.0-CPU	
Size	Document Number	Rev	Rev
A	1	1.0.2	4
Date:		Thursday, May 13, 2004	
Sheet		3 of 4	



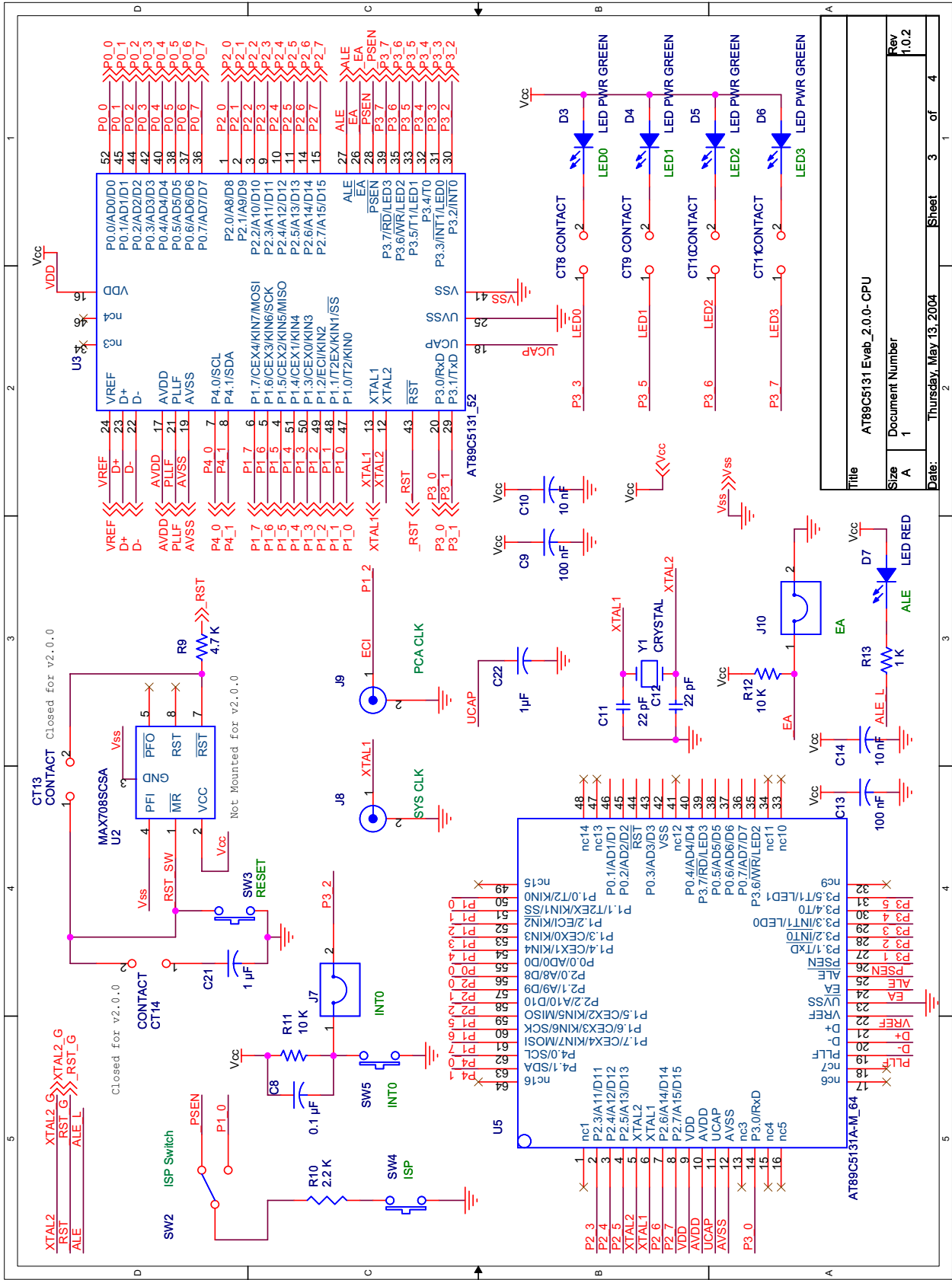

Title		AT89C5131 Evab_2.0.0-CPU	
Size	Document Number	Rev	
A	1	1.0.2	
Date:	Thursday, May 13, 2004	Sheet	3 of 4



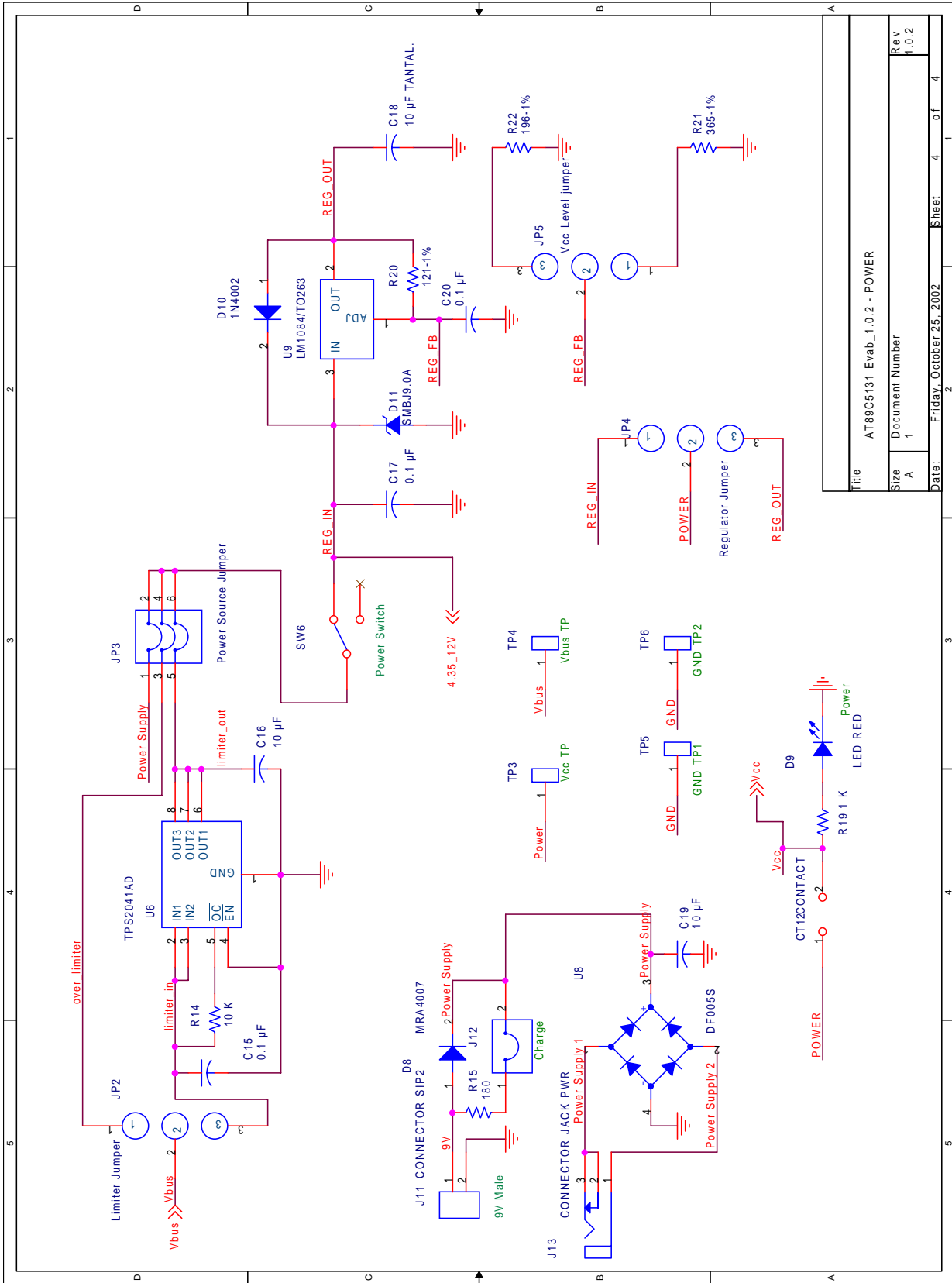

Title			
AT89C5131 Evab_1.0.2 - POWER			
Size	Document Number	Rev	
A	1	1.0.2	
Date: Friday, October 25, 2002		Sheet	4 of 4

4.2 Component Placement

Figure 4-1. AT89C5131A Evaluation Board Overview

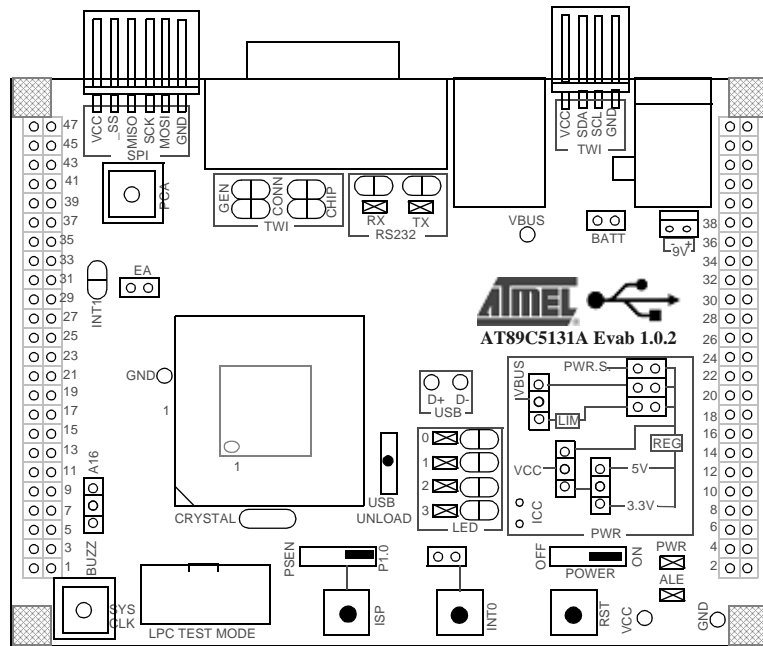
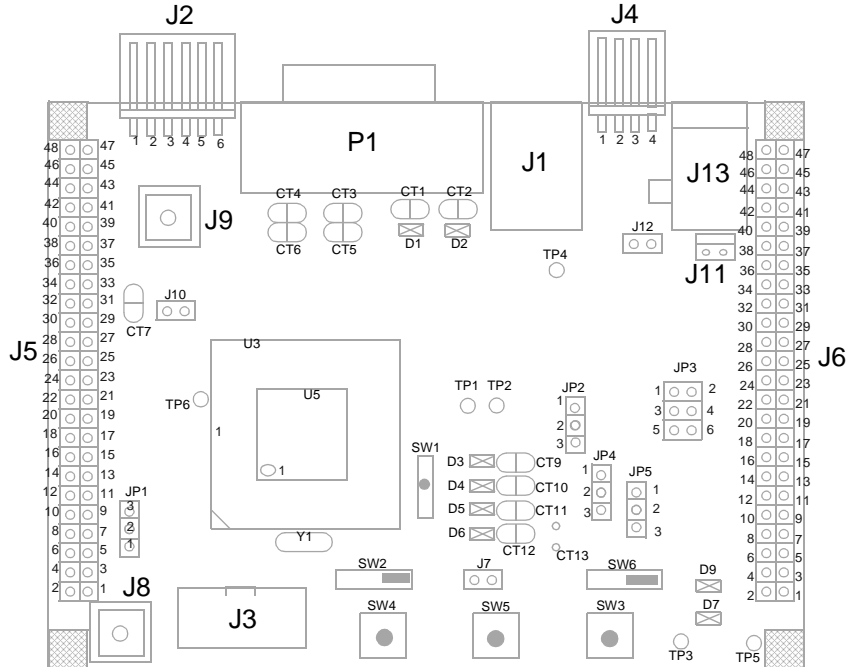
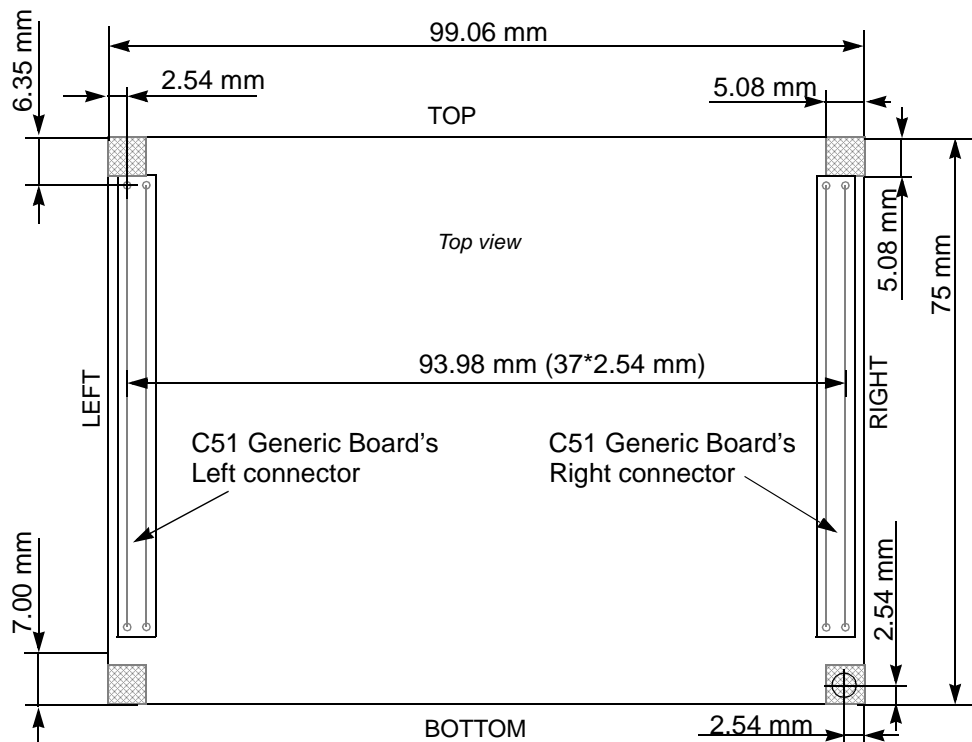

Figure 4-2. AT89C5131A Evaluation Board Component Implementation



4.3 Mechanical Outlines

Figure 4-3. AT89C5131A Evaluation Board Mechanical Outlines



4.4 Bill of Materials

Table 4-1. Bill of Materials

Reference	Part
C11, C12	22 pF
C2	2.2 nF
C1, C10, C14	10 nF
C9, C13	100 nF
C3, C4, C5, C6, C7, C8, C15, C17, C20, C21	0.1 μ F
C16, C19	10 μ F
R4, R5	27
R3	100
R15	180
R1, R6, R13, R19	1K
R2	1.5K
R10	2.2K
R7, R8, R9	4.7K
R11, R12, R14	10K



Table 4-1. Bill of Materials (Continued)

Reference	Part
D2	LED GREEN
D1, D7, D9	LEDs RED
D3, D4, D5, D6	LEDs PWR GREEN
D8	MRA4007
D11	SMBJ9.0A
U1	MAX202ECSE
U8	DF005S
TP1, TP2, TP3, TP4, TP5, TP6	TEST POINTS
J7, J10, J12	JUMPER
J13	CONNECTOR JACK PWR
J8, J9	CONNECTORS BNC
P1	SUB-D9 FEMALE
J1	USB B
J6, J5	HEADER 24X2
J11	CONNECTOR SIP2
J4	CONNECTOR SIP4 RA
J2	CONNECTOR SIP6 RA
J3	CONNECTOR HE10
SW2, SW6	SW KEY-SPDT
U3	AT89C5131A_52
U5	AT89C5131A_VQFP64
CT1, CT2, CT3, CT4, CT5, CT6, CT7, CT8, CT9, CT10, CT11, CT12, CT13, CT14	CONTACT
C18	10 μ F TANTAL
D10	1N4002
JP1	A16_Buzz Jumper
JP2	Limiter Jumper
JP3	Power Source Jumper
JP4	Regulator Jumper
JP5	V _{CC} Level jumper
R20	121-1%
R21	365-1%
R22	196-1%
SW1	CONTACT BREAKER



Table 4-1. Bill of Materials (Continued)

Reference	Part
SW3, SW4, SW5	PUSH-BUTTON
U2	MAX708SCSA
U6	TPS2041AD
U9	LM1084/TO263
Y1	CRYSTAL



Atmel Corporation

2325 Orchard Parkway
San Jose, CA 95131
Tel: 1(408) 441-0311
Fax: 1(408) 487-2600

Regional Headquarters

Europe

Atmel Sarl
Route des Arsenaux 41
Case Postale 80
CH-1705 Fribourg
Switzerland
Tel: (41) 26-426-5555
Fax: (41) 26-426-5500

Asia

Room 1219
Chinachem Golden Plaza
77 Mody Road Tsimshatsui
East Kowloon
Hong Kong
Tel: (852) 2721-9778
Fax: (852) 2722-1369

Japan

9F, Tonetsu Shinkawa Bldg.
1-24-8 Shinkawa
Chuo-ku, Tokyo 104-0033
Japan
Tel: (81) 3-3523-3551
Fax: (81) 3-3523-7581

Atmel Operations

Memory

2325 Orchard Parkway
San Jose, CA 95131
Tel: 1(408) 441-0311
Fax: 1(408) 436-4314

Microcontrollers

2325 Orchard Parkway
San Jose, CA 95131
Tel: 1(408) 441-0311
Fax: 1(408) 436-4314

La Chantrerie
BP 70602
44306 Nantes Cedex 3, France
Tel: (33) 2-40-18-18-18
Fax: (33) 2-40-18-19-60

ASIC/ASSP/Smart Cards

Zone Industrielle
13106 Rousset Cedex, France
Tel: (33) 4-42-53-60-00
Fax: (33) 4-42-53-60-01

1150 East Cheyenne Mtn. Blvd.
Colorado Springs, CO 80906
Tel: 1(719) 576-3300
Fax: 1(719) 540-1759

Scottish Enterprise Technology Park
Maxwell Building
East Kilbride G75 0QR, Scotland
Tel: (44) 1355-803-000
Fax: (44) 1355-242-743

RF/Automotive

Theresienstrasse 2
Postfach 3535
74025 Heilbronn, Germany
Tel: (49) 71-31-67-0
Fax: (49) 71-31-67-2340

1150 East Cheyenne Mtn. Blvd.
Colorado Springs, CO 80906
Tel: 1(719) 576-3300
Fax: 1(719) 540-1759

Biometrics/Imaging/Hi-Rel MPU/ High Speed Converters/RF Datacom

Avenue de Rochepleine
BP 123
38521 Saint-Egreve Cedex, France
Tel: (33) 4-76-58-30-00
Fax: (33) 4-76-58-34-80

e-mail

literature@atmel.com

Web Site

<http://www.atmel.com>

Disclaimer: Atmel Corporation makes no warranty for the use of its products, other than those expressly contained in the Company's standard warranty which is detailed in Atmel's Terms and Conditions located on the Company's web site. The Company assumes no responsibility for any errors which may appear in this document, reserves the right to change devices or specifications detailed herein at any time without notice, and does not make any commitment to update the information contained herein. No licenses to patents or other intellectual property of Atmel are granted by the Company in connection with the sale of Atmel products, expressly or by implication. Atmel's products are not authorized for use as critical components in life support devices or systems.

© Atmel Corporation 2004. All rights reserved. Atmel® and combinations thereof are the registered trademarks of Atmel Corporation or its subsidiaries. Other terms and product names may be the trademarks of others.



Printed on recycled paper.